

MIMO Communication Systems Modeling and Simulation in Capsim

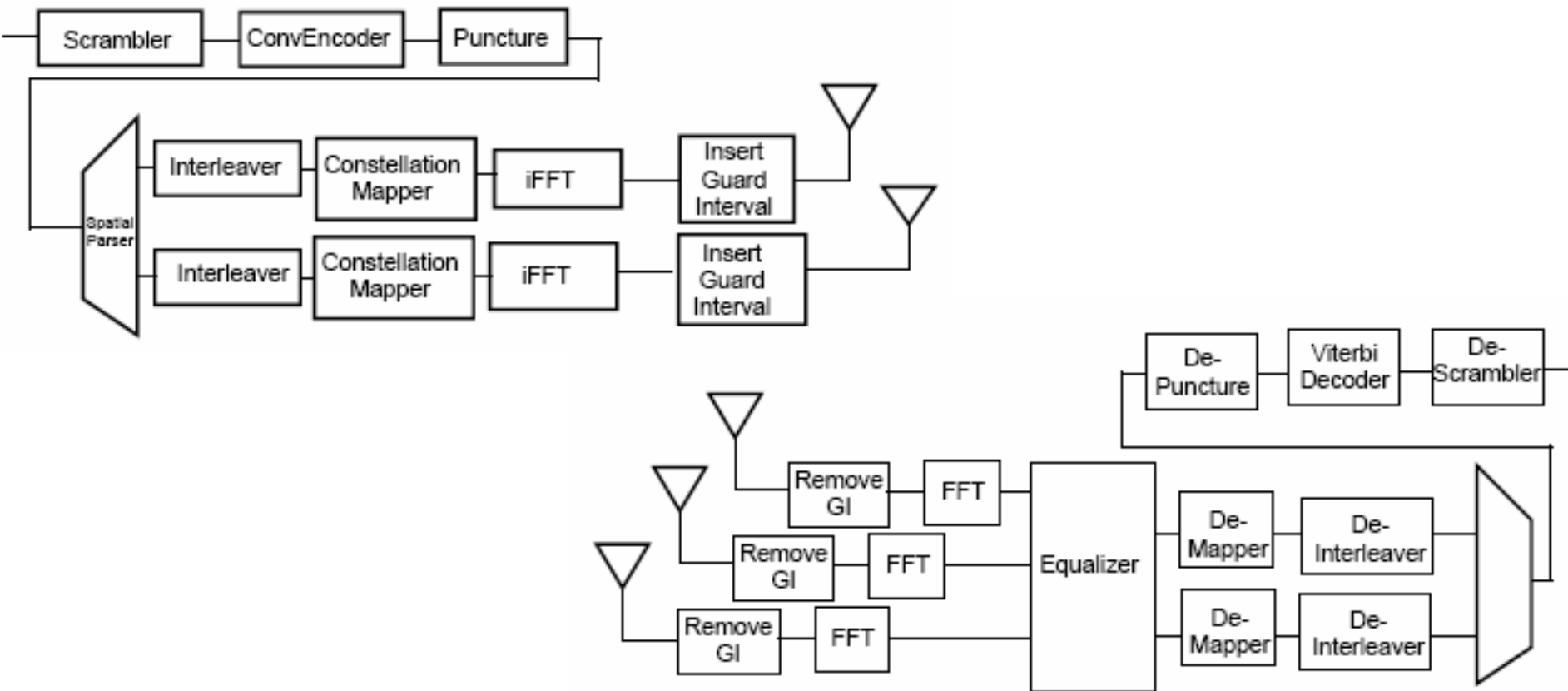

2x3 MIMO OFDM System



Capsim 2x3 MIMO System

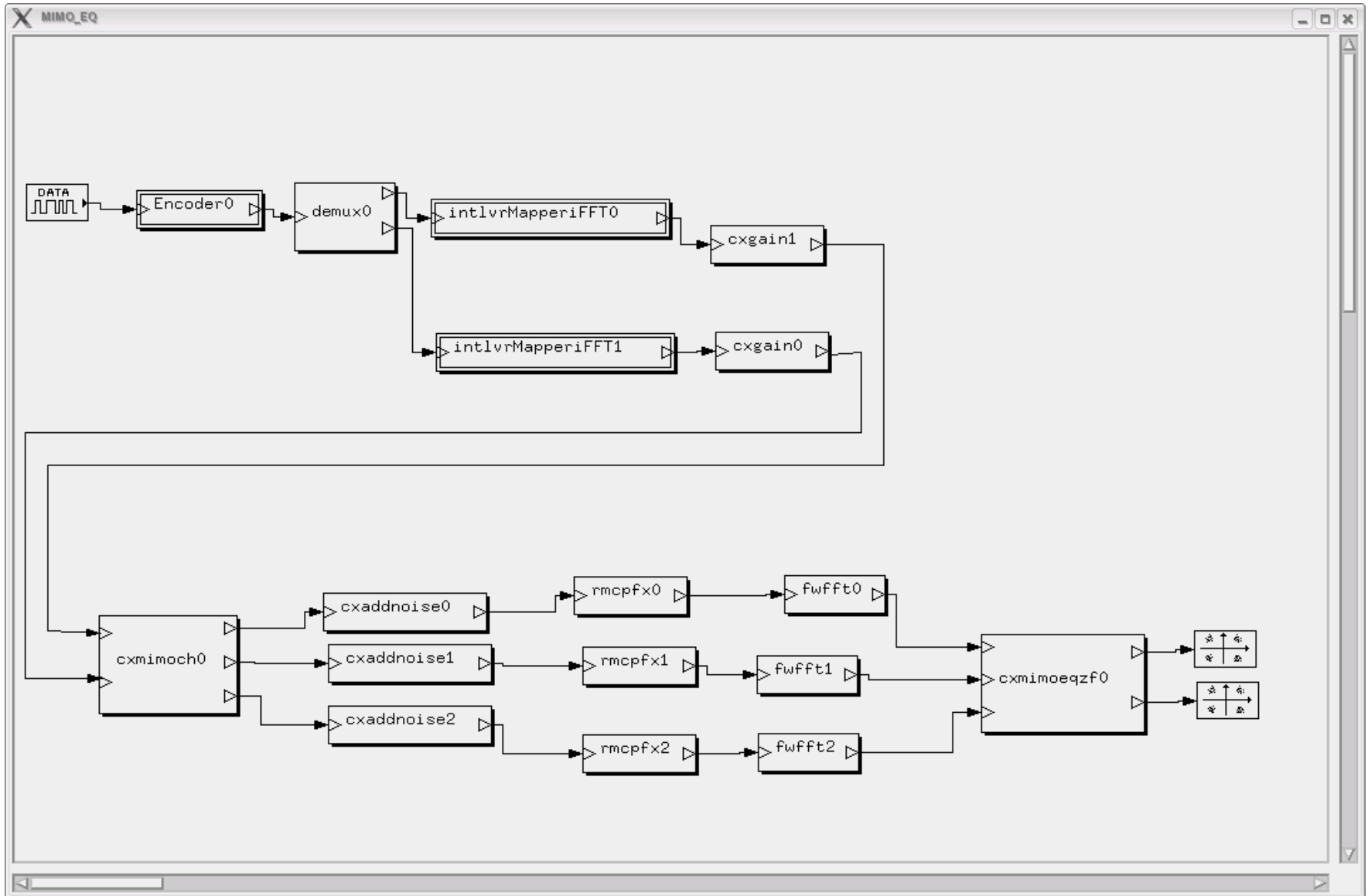

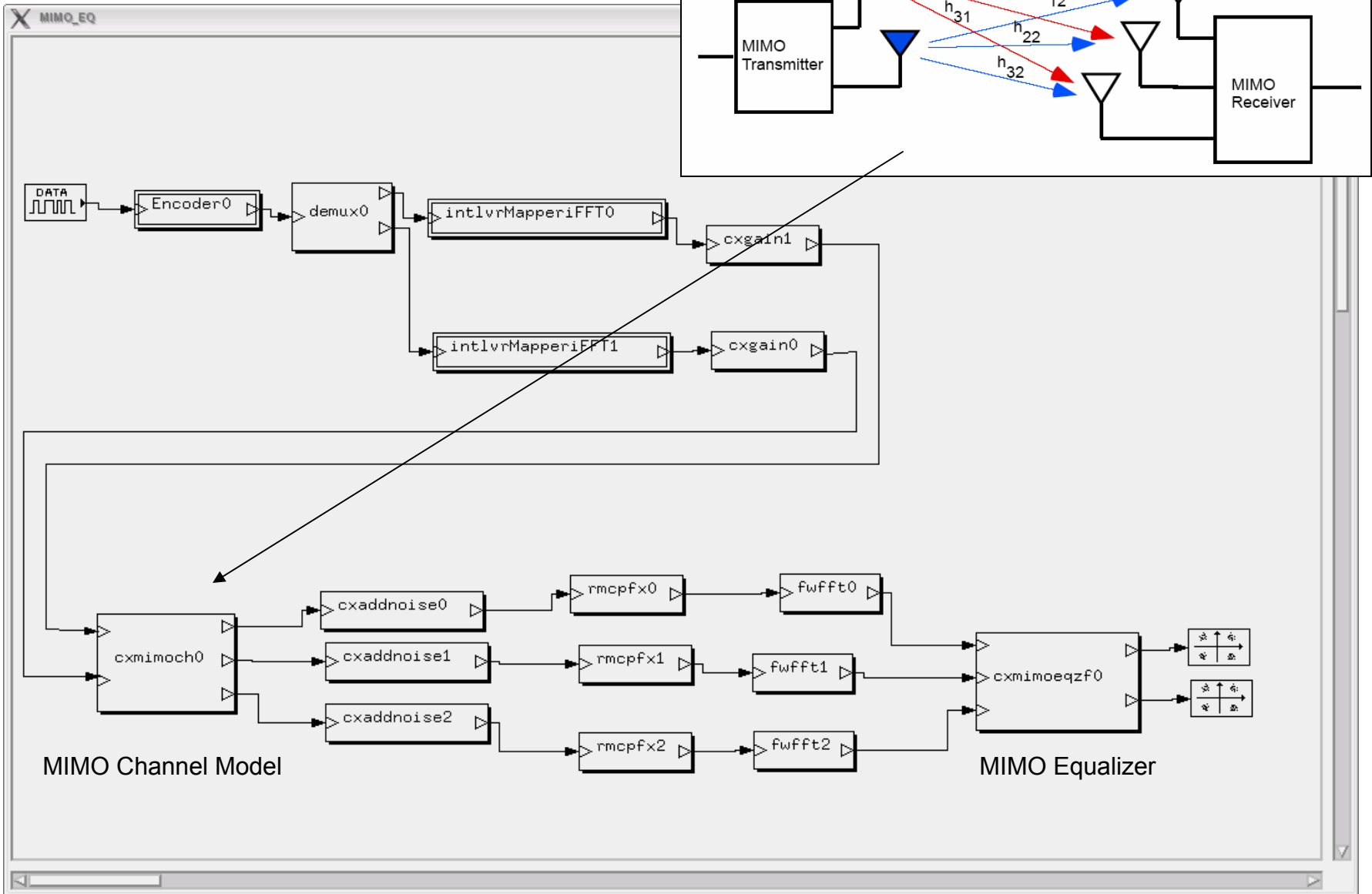

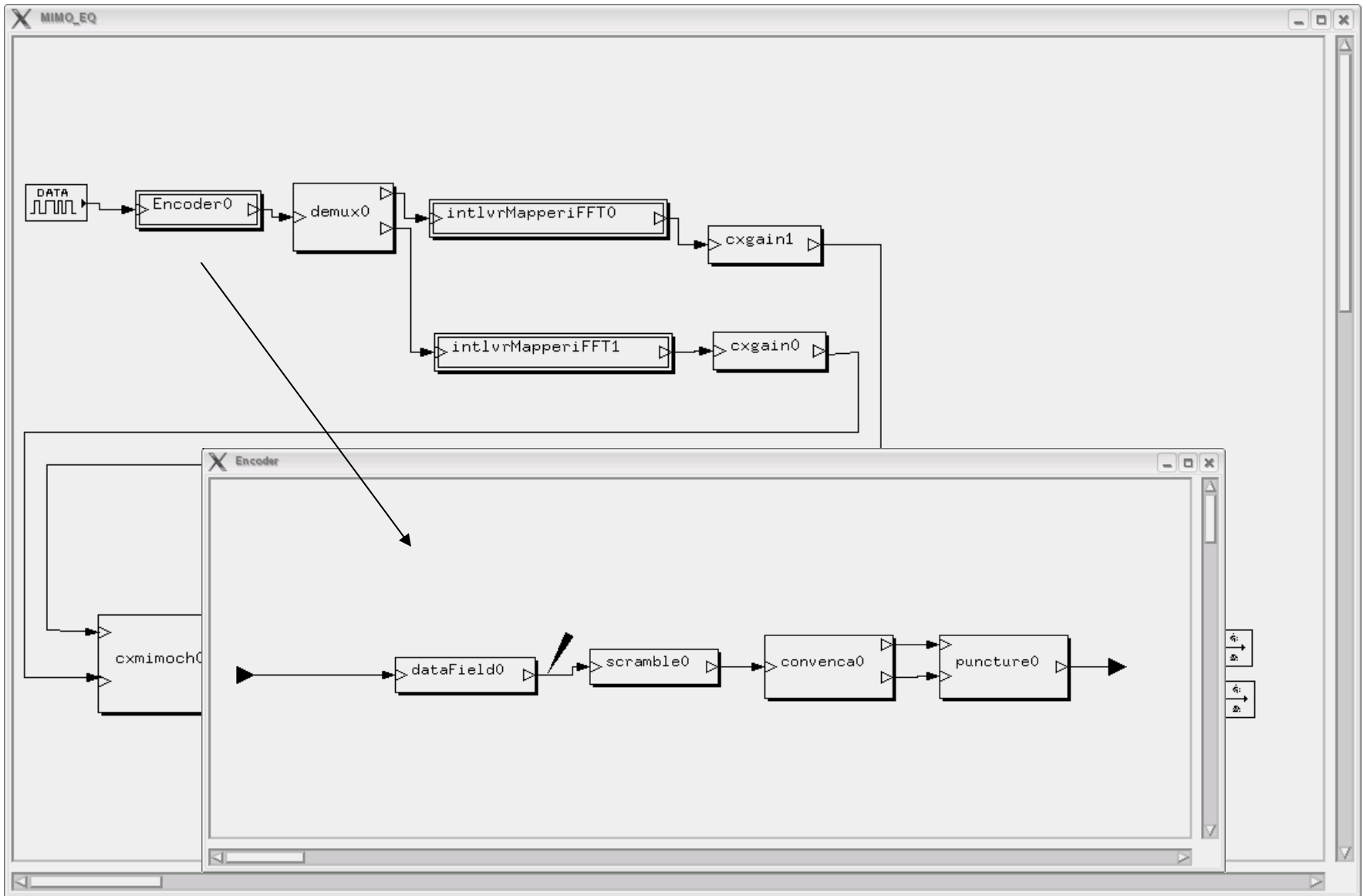

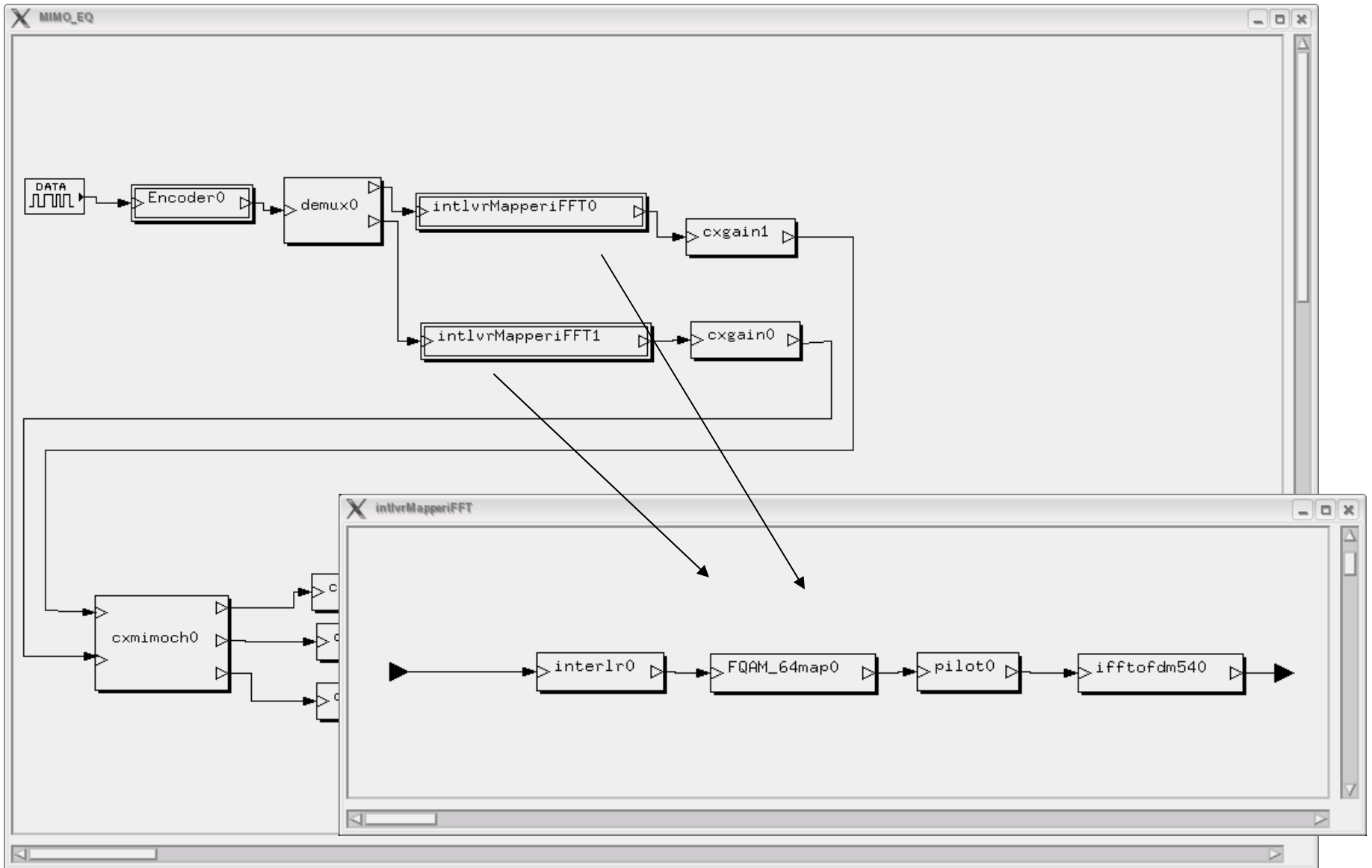

Capsim 2x3 MIMO System

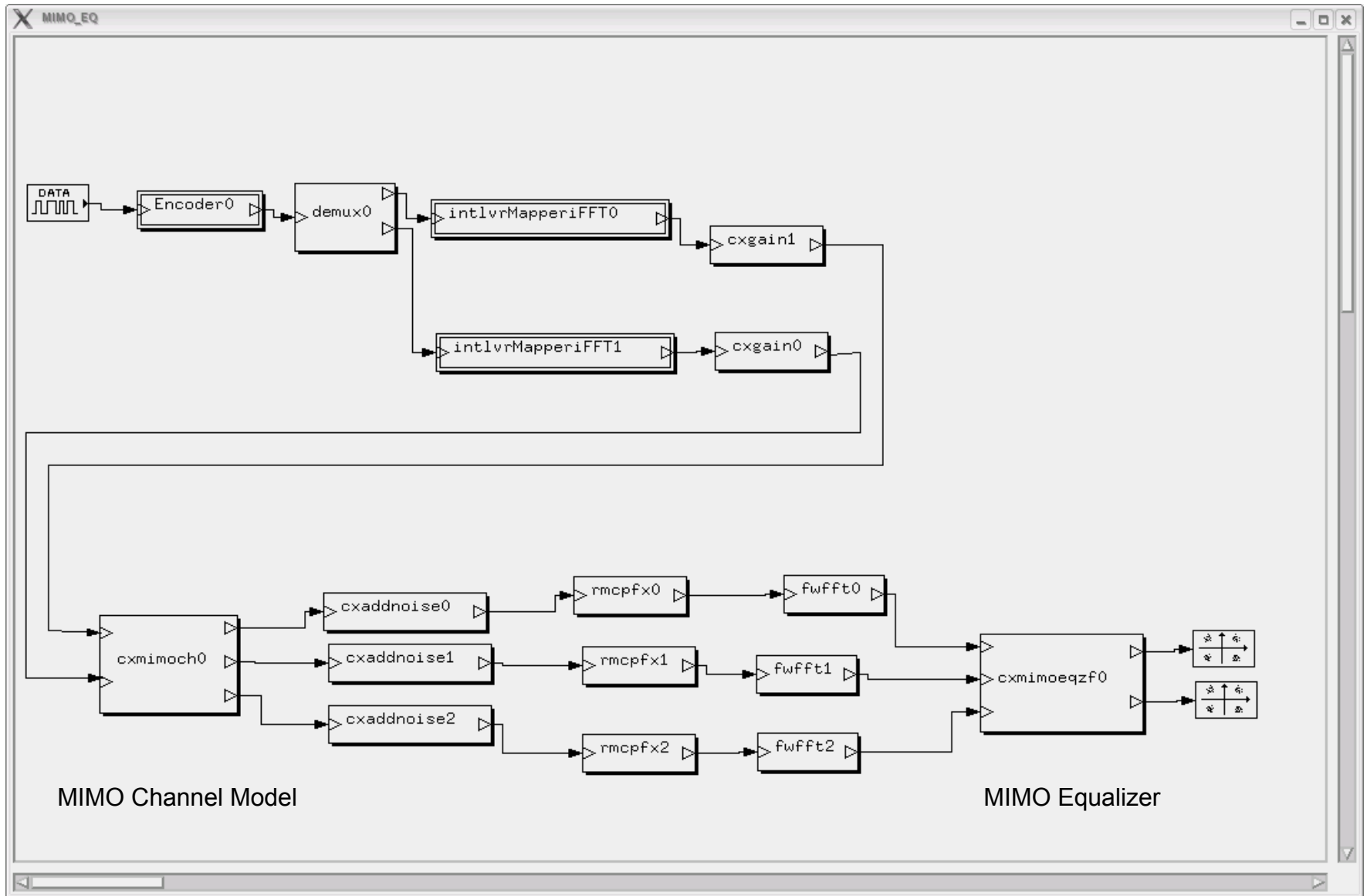

Capsim 2x2 MIMO System

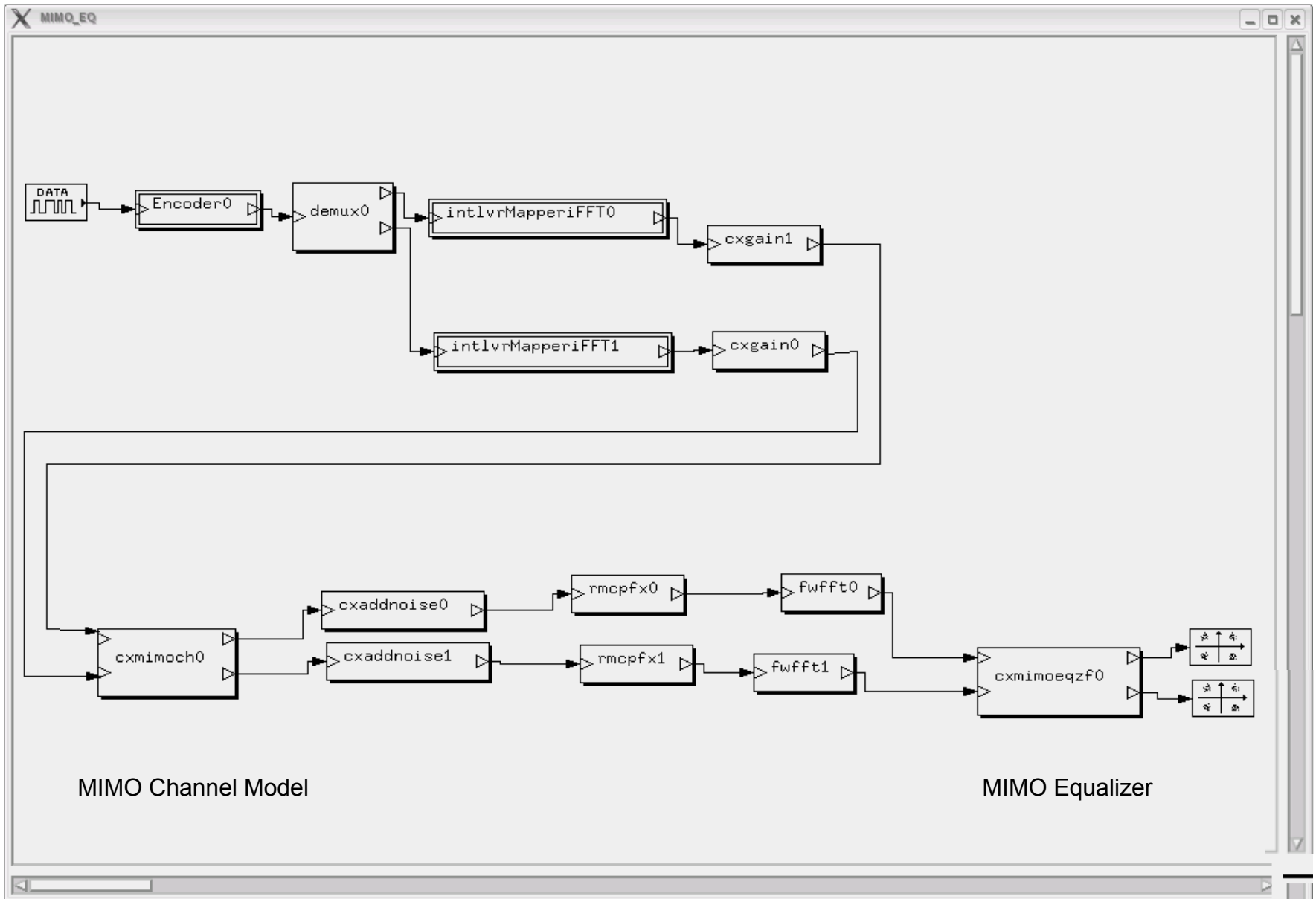

2x2 Strong Weak

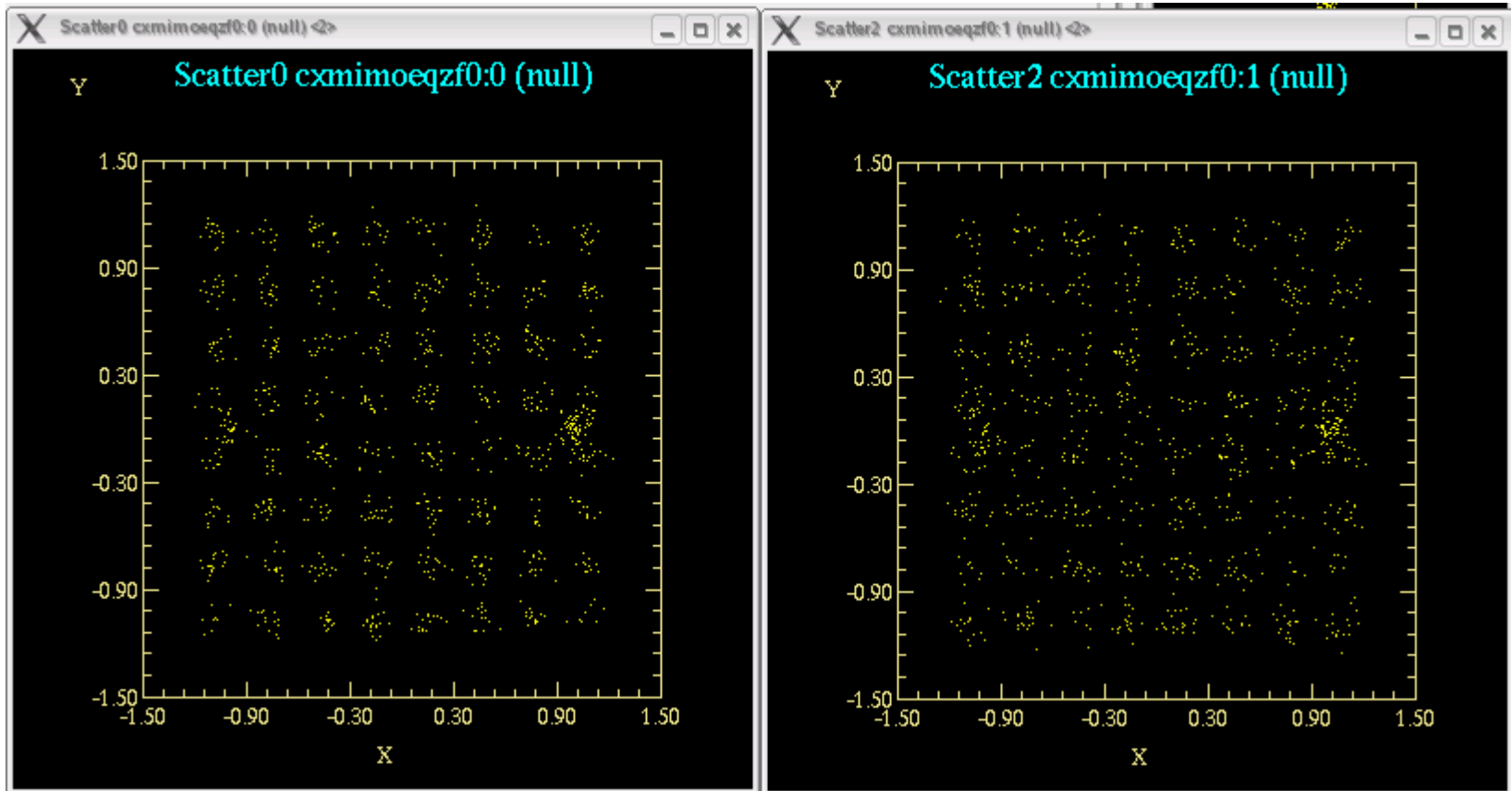

2x3 Strong Weak

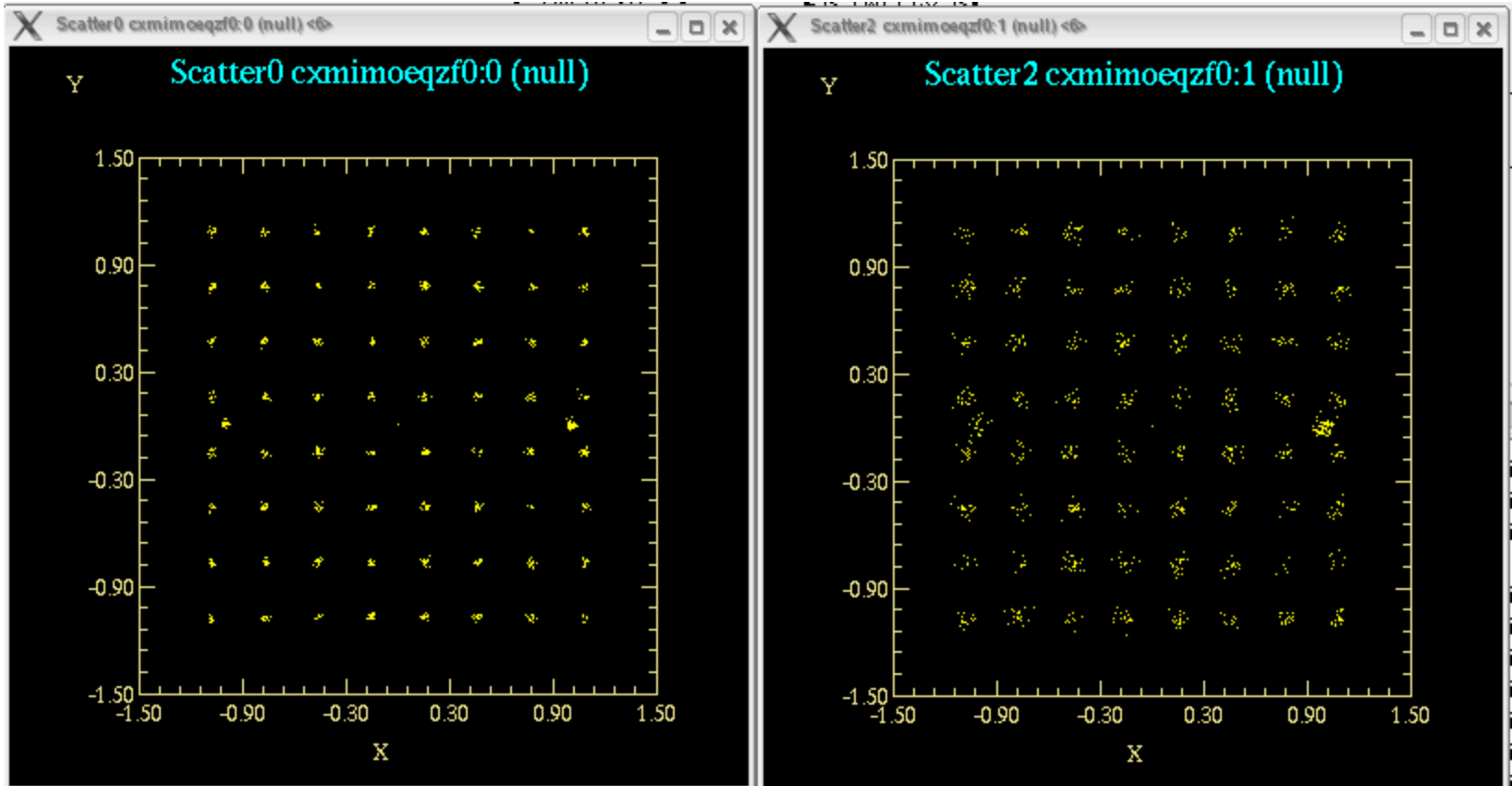

2x3 Equal

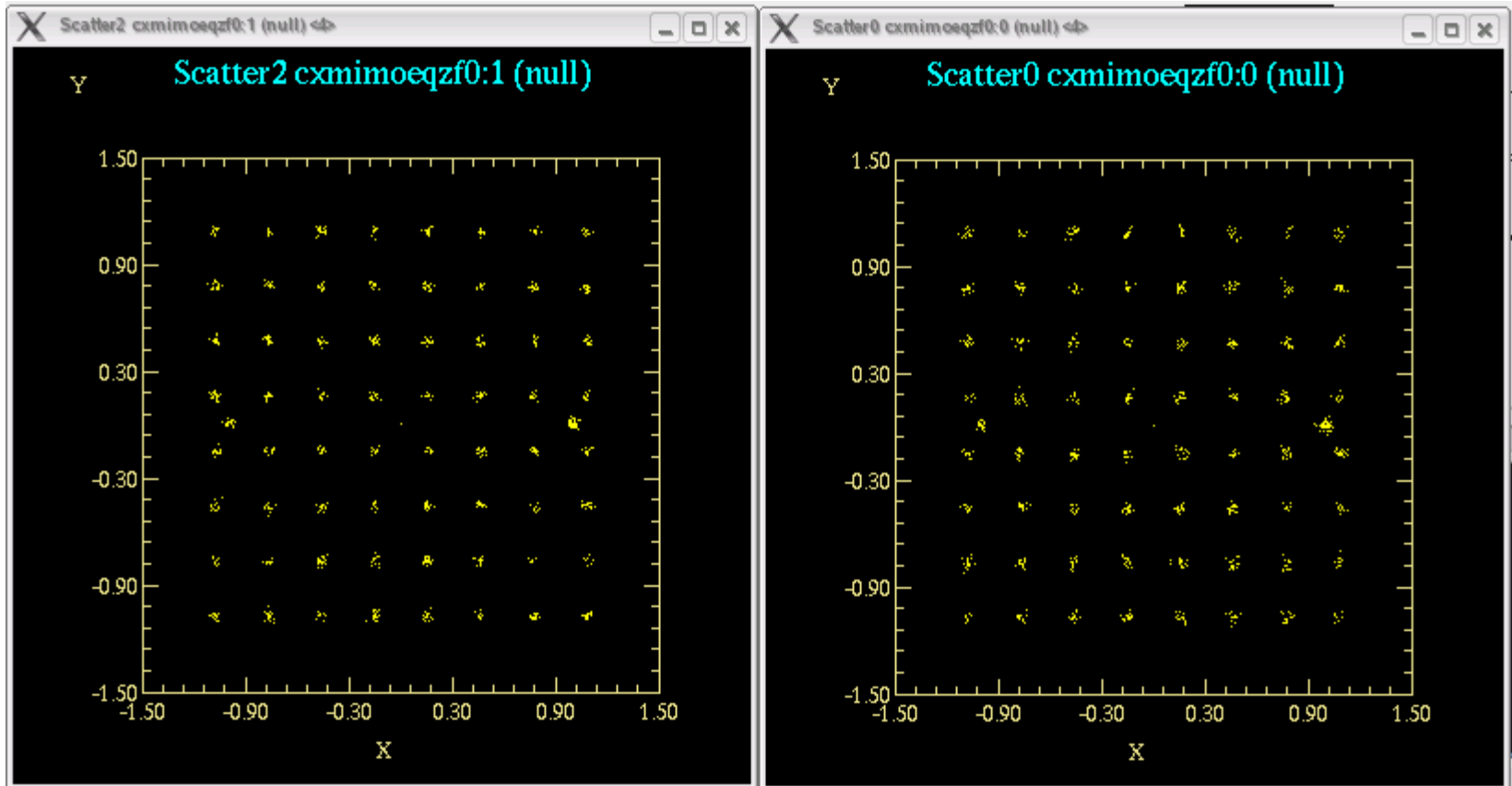

2x3 Strong Weak

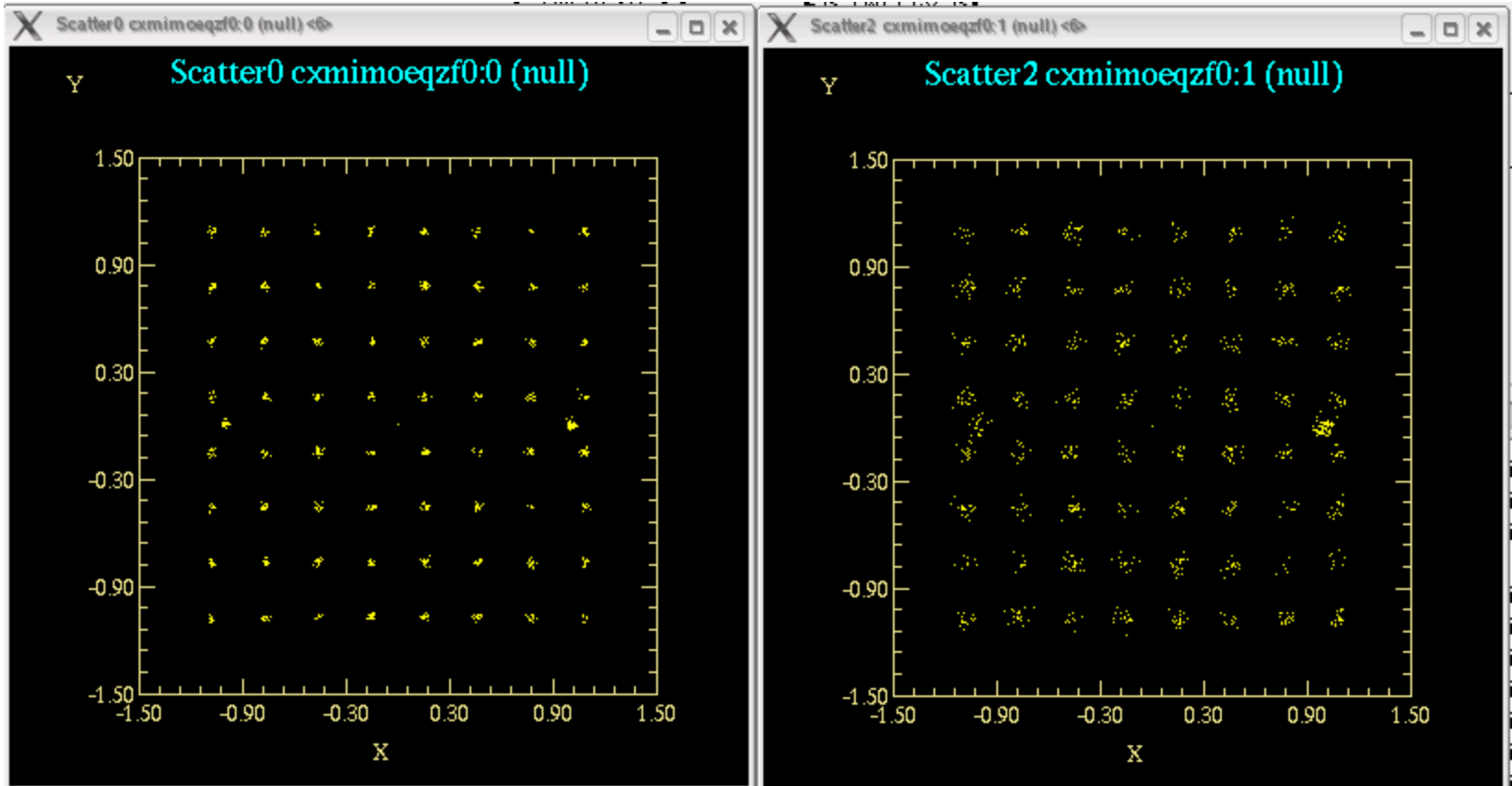

SISO

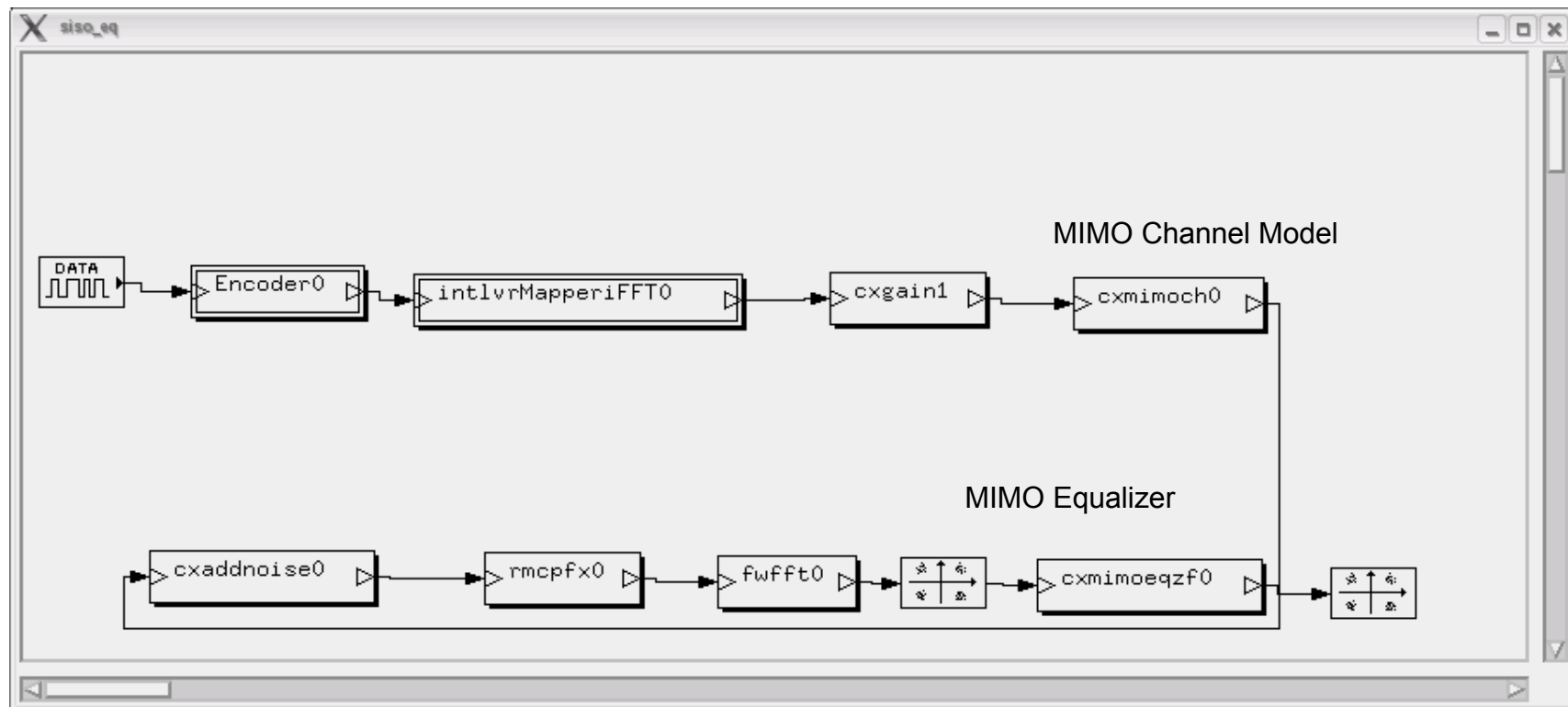

MRC

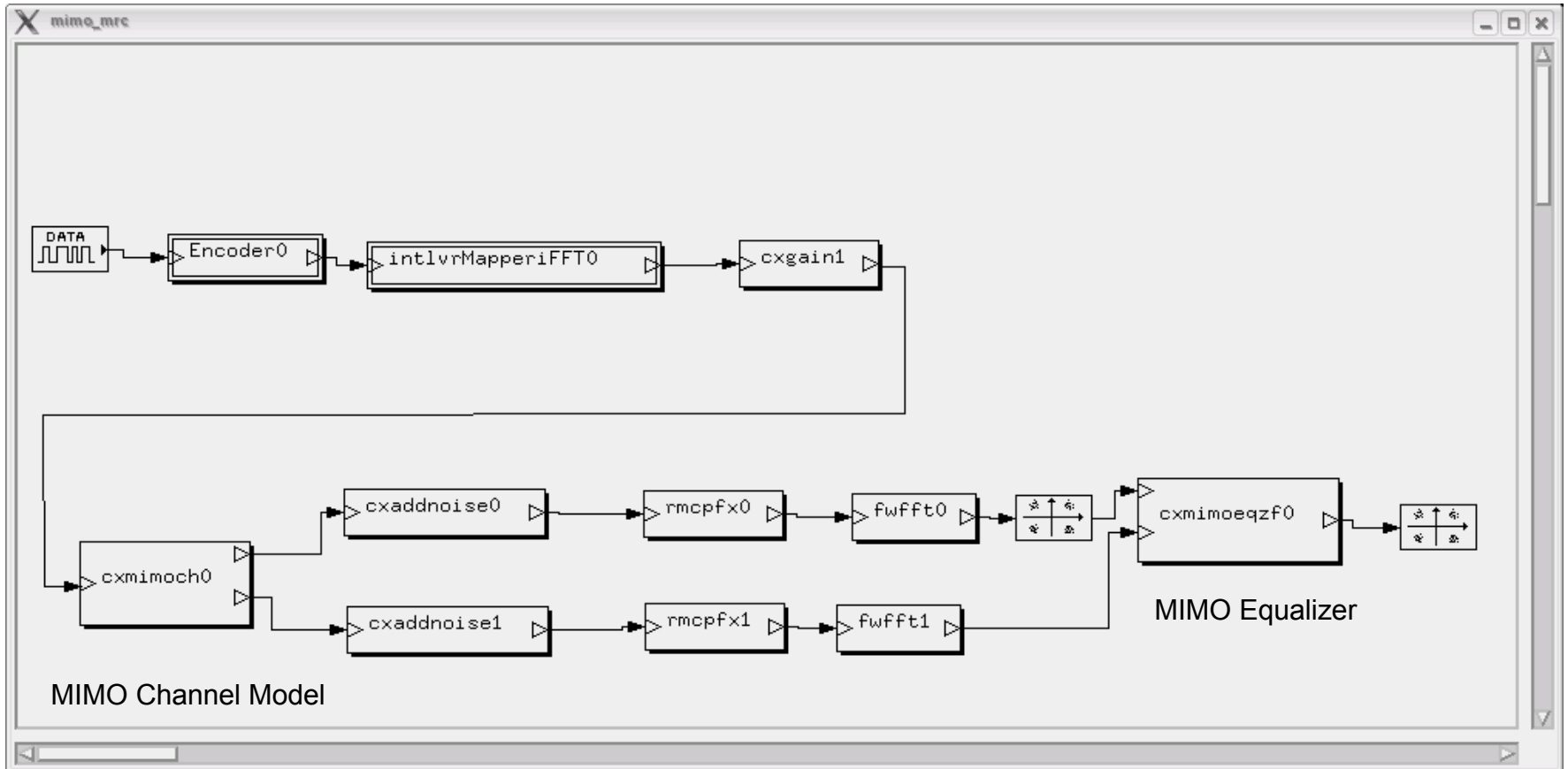

SISO versus MRC

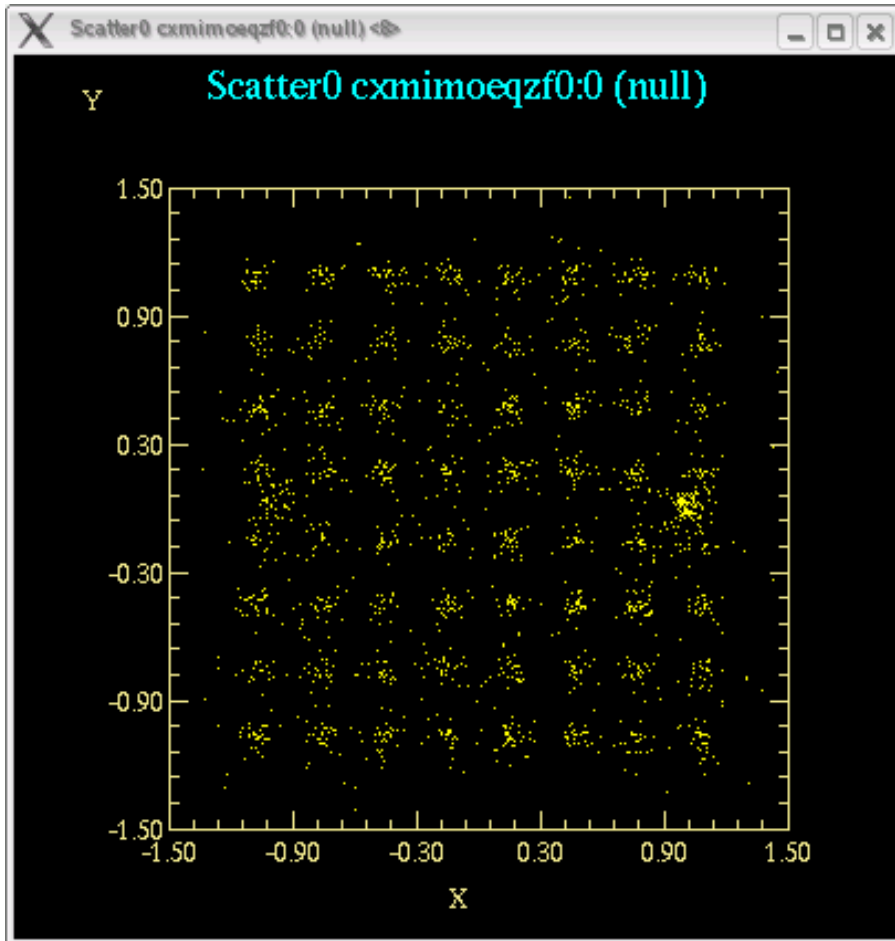

SISO

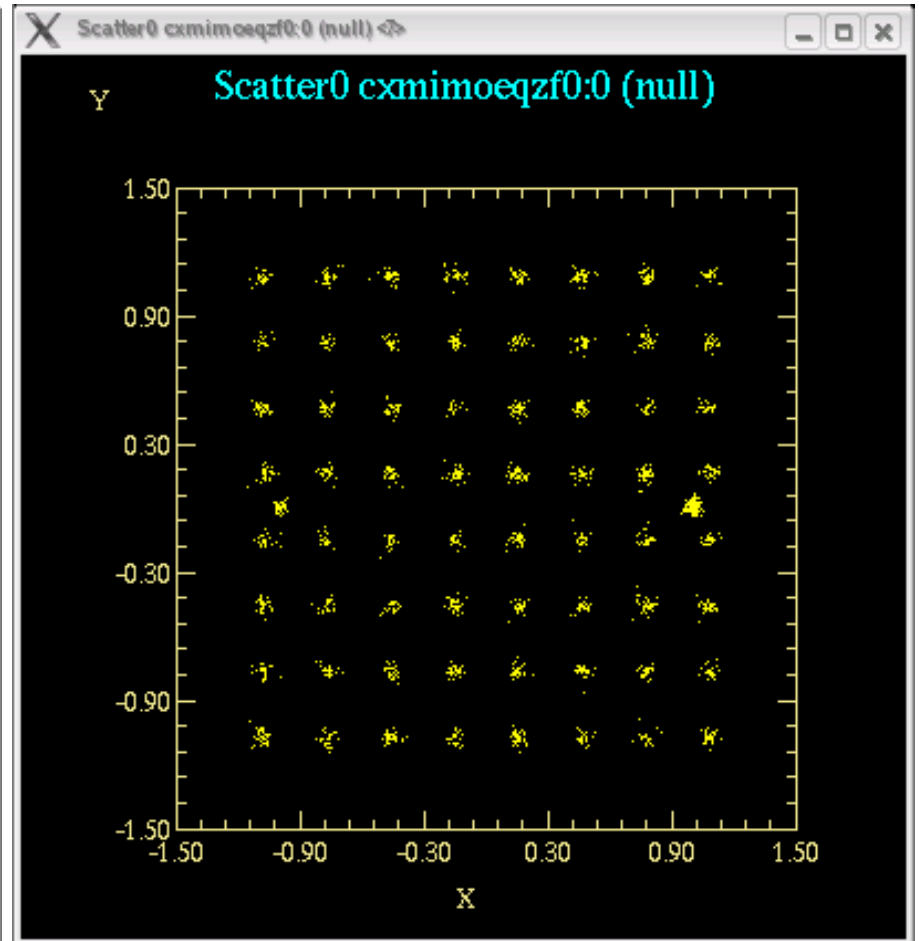

MRC